

# CF 105 CABLOFIL CABLE TRAY

# CABLOFIL®

INNOVATORS IN CABLE MANAGEMENT

8319 State Route 4  
 Mascoutah IL 62258  
 Phone: 800-658-4641  
 618-566-3230  
 Fax: 618-566-3250  
[www.cablofil.com](http://www.cablofil.com)

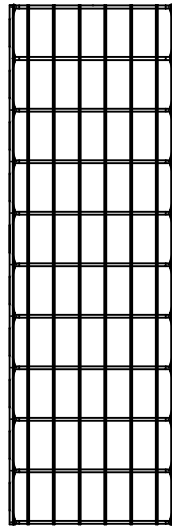

TOP

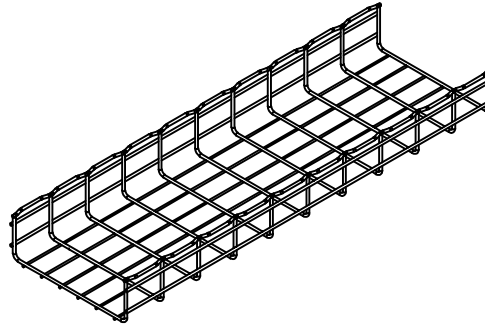

ISOMETRIC



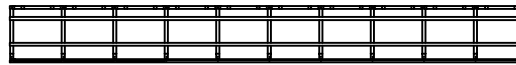

FRONT



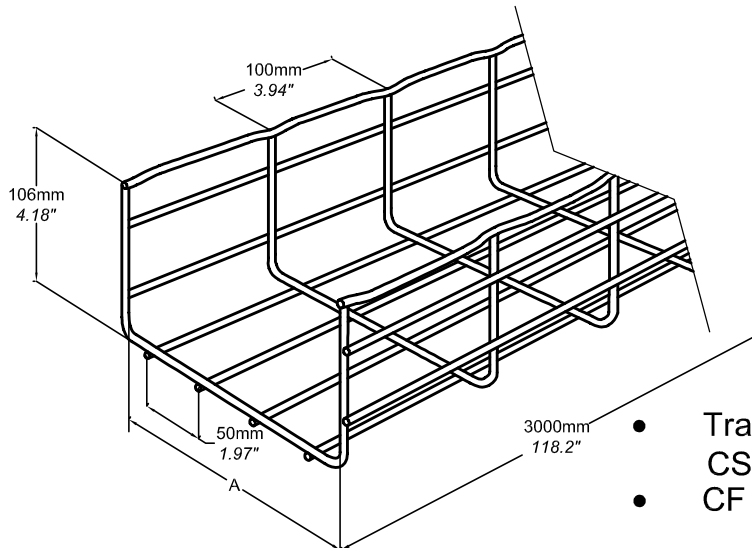









SIDE



- Tray designed per NEMA VE-1, CSA C22.2 No. 126
- CF has top wave wire (shown)

			
	in	mm	lb
CF105 100	3.937	100	9.0
CF105 150	5.904	150	10.2
CF105 200	7.872	200	13.4
CF105 300	11.81	300	21.2
CF105 450	17.71	450	25.9
CF105 500	19.68	500	27.5
CF105 600	23.62	600	30.4

	Material	Finish
EZ	Carbon Steel ASTM A510 Grade 1008	Electroplated Zinc, ASTM B633
GC	Carbon Steel ASTM A510 Grade 1008	Hot-Dip Galvanized ASTM A123
BL	Carbon Steel ASTM A510 Grade 1008	Black Painted ASTM D 3451
PE	Carbon Steel ASTM A510 Grade 1008	Custom Painted ASTM D 3451
304L	AISI TYPE 304L	Passivated ASTM A 380
316L	AISI TYPE 316L	Passivated ASTM A 380